



RF-LAMBDA

The power beyond expectations

REMC34G36GD

25W Solid State EMC Benchtop Power Amplifier 34GHz~36GHz

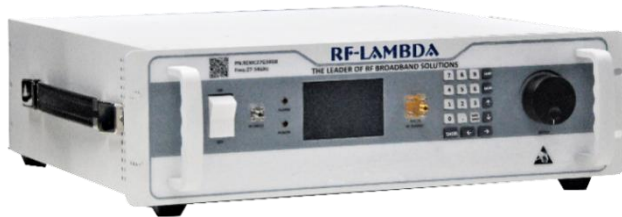

Features

- Automatic Calibration
- Built in Temperature Compensation
- Adjustable Attenuation:
31.5dB Range, 0.5dB Step Size
- Supply Voltage: 110V/220V AC

Typical Applications

- Aerospace and military applications
- Test and Measurement.
- Research and Development.

Electrical Specifications, $T_A=25\text{ }^\circ\text{C}$

Parameter	Min.	Typ.	Max.	Units
Frequency Range	34 - 36			GHz
Gain		50		dB
Gain Variation Over Temperature (-45 ~ +85)		-		dB
Input Return Loss		-		dB
Output Return Loss		-		dB
Saturated Output Power (Psat)		44		dBm
Output Third Order Intercept (IP ₃)		-		dBm
Isolation S ₁₂		-		dB
Input Max Power (No Damage)	Psat - Gain			dBm
Weight	35			lbs
Impedance	50			Ohms
Power Supply Connector	D-SUB COMBO 3POS			
Input / Output Connectors	Input: 2.9mm female, Output: 2.92mm female or WR28			
Material	Aluminum / Copper			

25W Wide Band Solid State EMC-Benchtop Power Amplifier 34-36GHz



RF-LAMBDA

The power beyond expectations

REMC34G36GD

Absolute Maximum Ratings	
Supply Voltage	110V 220V ac
RF Input Power (RFIN) Pin max = Psat - Gainsat	Psat - Gain
Storage Temperature (°C)	-50 to +125

Note: Maximum RF input power is set to assure safety of amplifier. Input power may be increased at own risk to achieve full power of amplifier. Please reference gain and power curves

Biasing Up Procedure	
Step 1	Connect input and output with 50 Ohm source/load. (in band VSWR<1.9:1 or >10dB return loss)
Step 2	Turn on AC power.
Step 3	Enable RF output
Power OFF Procedure	
Step 1	Turn off RF output power
Step 2	Turn Off AC power
Step 3	Disconnect input and output

Environmental Specifications and Test Standards

Parameter	Standard	Description
Operational Temperature	MIL-STD-39016	-45°C~+85°C
Storage Temperature		-55°C~+125°C
Thermal Shock		1 Hour@ -45°C → 1 Hour @ +85°C (5 Cycles)
Random Vibration		Acceleration Spectral Density 6 (m/s) Total 92.6 RMS
Electrical & Temperature Burn In		Temperature +85°C for 72 Hours
Shock		1. Weight >20g, 50g half sine wave for 11ms, Speed variation 3.44m/s 2. Weight <=20g, 100g Half sine wave for 6ms, Speed variation 3.75m/s 3. Total 18 times (6 directions, 3 repetitions per direction).
Altitude		Standard: 30,000 Ft (Epoxy Sealed Controlled Environment) Optional: Hermetically Sealed (60,000 ft. 1.0 PSI min)
Hermetically Sealed (Optional)	MIL-STD-883	MIL-STD-883 (For Hermetically Sealed Units)

Note: The operating temperature for the unit is specified at the package base. It is the user's responsibility to ensure the part is in an environment capable of maintaining the temperature within the specified limits

25W Wide Band Solid State EMC-Benchtop Power Amplifier 34-36GHz



Ordering Information	
Part No.	Description
REMC34G36GD	34GHz~36GHz Power Amplifier

Amplifier Use

Ensure that the amplifier input and output ports are safely terminated into a proper 50 ohm load before turning on the power. Never operate the amplifier without a load. A proper 50 ohm load is defined as a load with impedance less than 1.9:1 or return loss larger than 10dB relative to 50 Ohm within the specified operating band width.

Power Supply Requirements

Power supply must be able to provide adequate current for the amplifier. Power supply should be able to provide 1.5 times the typical current or 1.2 times the maximum current (whichever is greater).

In most cases, RF - Lambda amplifiers will withstand severe mismatches without damage. However, operation with poor loads is discouraged. If prolonged operation with poor or unknown loads is expected, an external device such as an isolator or circulator should be used to protect the amplifier.

Ensure that the power is off when connecting or disconnecting the input or output of the amp.

Prevent overdriving the amplifier. Do not exceed the recommended input power level.

Adequate heat-sinking required for RF amplifier modules. Please inquire.

Amplifiers do not contain Thermal protection, Reverse DC polarity or Over voltage protection with the exception of a few models. Please inquire.

Proper electrostatic discharge (ESD) precautions are recommended to avoid performance degradation or loss of functionality.

What is not covered with warranty?

Each RF - Lambda amplifier will go through power and temperature stress testing.

Since the die, ICs or MMICs are fragile, these are not covered by warranty. Any damage to these will NOT be free to repair.



RF-LAMBDA

The power beyond expectations

REMC34G36GD

Outline Drawing:

All Dimensions in mm [inches]

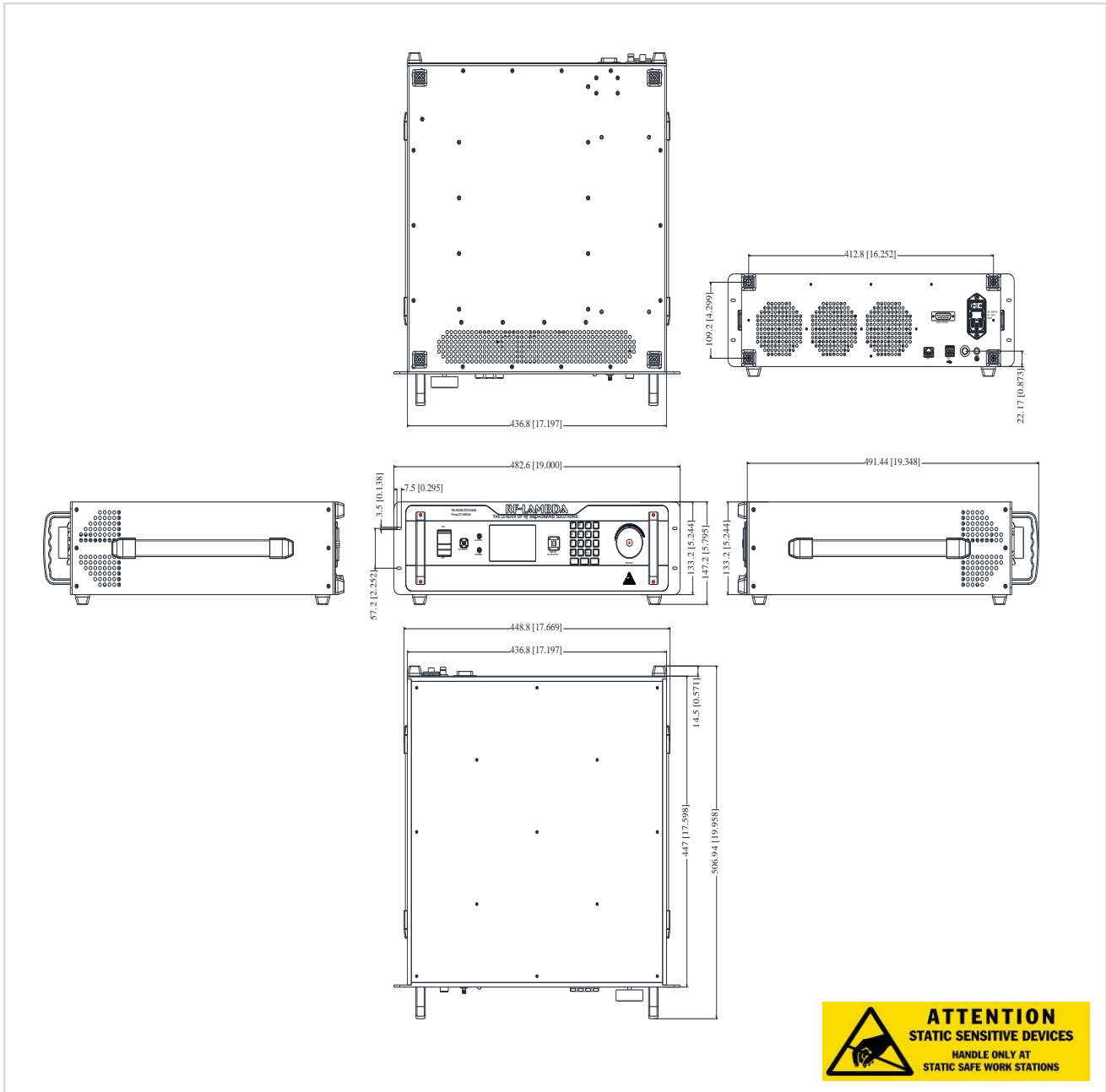

25W Wide Band Solid State EMC-Benchtop Power Amplifier 34-36GHz

Important Notice

The information contained herein is believed to be reliable. RF-Lambda makes no warranties regarding the information contained herein. RF-Lambda assumes no responsibility or liability whatsoever for any of the information contained herein. RF-Lambda assumes no responsibility or liability whatsoever for the use of the information contained herein. The information contained herein is provided "AS IS, WHERE IS" and with all faults, and the entire risk associated with such information is entirely with the user. All information contained herein is subject to change without notice. Customers should obtain and verify the latest relevant information before placing orders for RF-Lambda products. The information contained herein or any use of such information does not grant, explicitly or implicitly, to any party any patent rights, licenses, or any other intellectual property rights, whether with regard to such information itself or anything described by such information. RF-Lambda products are not warranted or authorized for use as critical components in medical, life-saving, or life sustaining applications, or other applications where a failure would reasonably be expected to cause severe personal injury or death.



EMC Equipment User Manual

Front Panel



Rear Panel

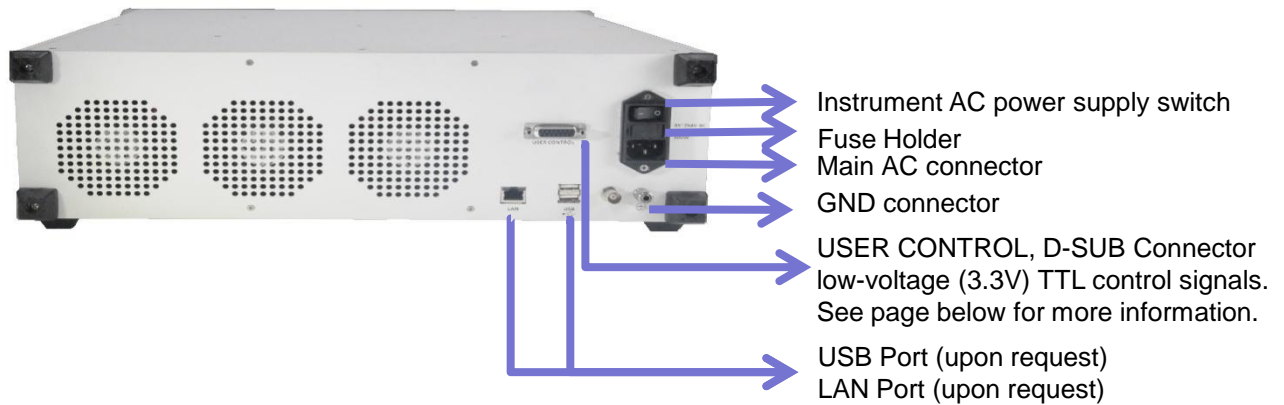

25W Wide Band Solid State EMC-Benchtop Power Amplifier 34-36GHz



Front Panel LCD Screen Display

Switching On Instrument

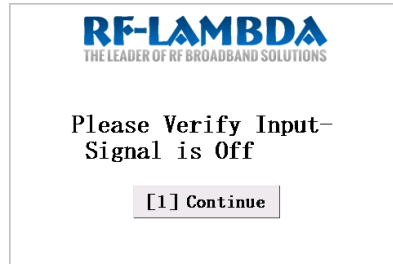

Please follow the instructions on the front panel LCD screen after switching on the power. Press "1" on keypad to continue.

Self Calibration Screen

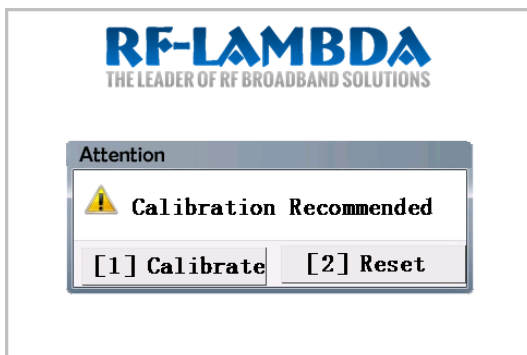

Calibration is may be recommended "**[1] Calibrate**" to execute instrument self calibration process.

"**[2] Reset**" to reboot the instrument.

*Please turn OFF RF input power, and terminate the RF output port while applying calibration function

Instrument Protection Alarms

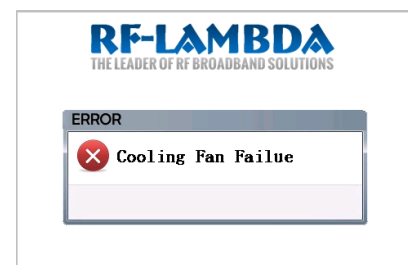
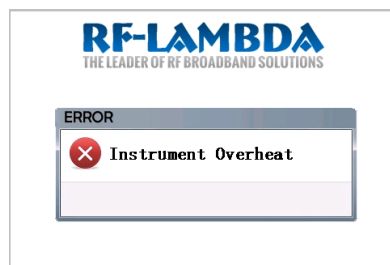
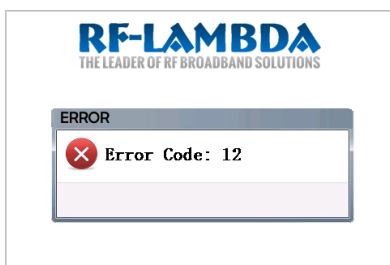

The front panel LCD screen will display the error code or error message when instrument self protection is triggered. Front panel alarm indicator will light up.

To eliminate the error code, press "RESET" on front panel keypad to reboot the instrument and clear the alarms.

If error code can not be eliminated after reboot, please contact support@rflambda.com



Instrument Status Display Page

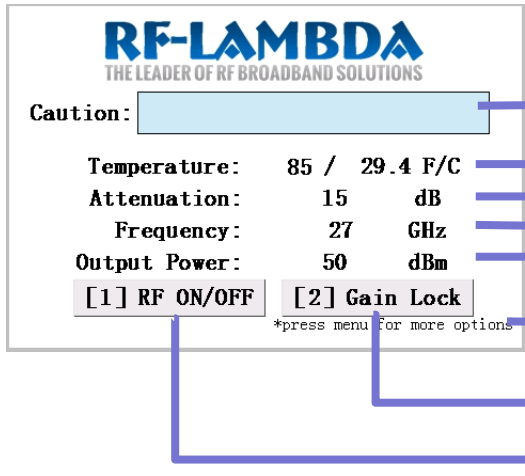

Indicates instrument RF output status. It will display: Output is Ready to Turn on or RF Output is ON

Instrument temperature

RF output attenuation (change with adjustment knob)

RF input signal center frequency

Instrument RF output power

Press "Menu" on keypad to enter instrument functions selection menu

User can set a constant gain for the unit. Equipment will automatically adjust the gain at certain frequency

Switches On or Off for instrument RF output port

Instrument Function Selection Page

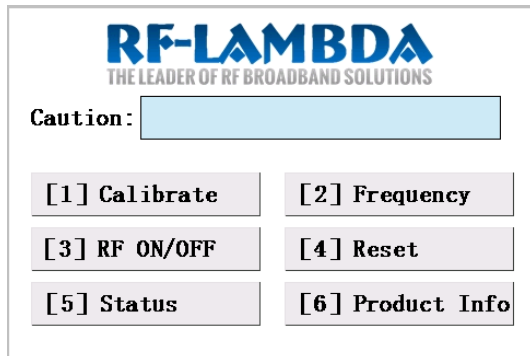

To enter this function selection page, press "Menu" on front panel keypad while the instrument is showing the status page. Press the corresponding number on front panel keypad to select:

"[1] Calibrate" calibrates the instruments.

"[2] Frequency" enters RF input signal center frequency.

"[3] RF ON/OFF" switches the RF output port on or off.

"[4] Reset" Restarts the instrument (Turns RF output off)

"[5] Status" enters instrument status display page.

"[6] Product Info" displays product part number and serial number

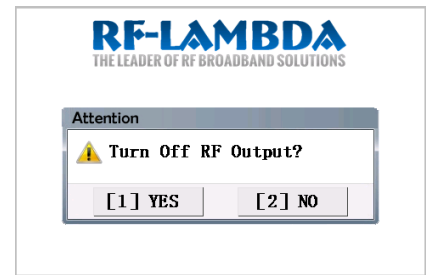
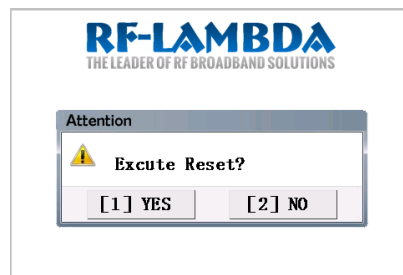
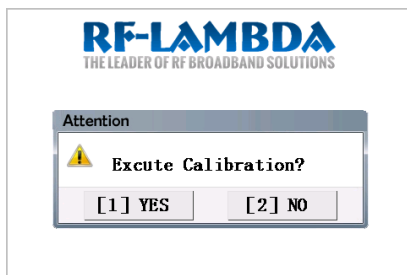

All action functions will ask for confirming execution when selected from function selection menu.



User Control Connector on Rear Panel

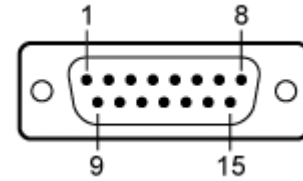

Pin #	Name	Function	Initial State	Description	Applied
1	Reset	Control		Resets PA when logic <u>LOW</u> is applied and released	Yes
2	Driver Disable	Control	LOW	Applying logic <u>HIGH</u> disables driver of amplifiers	Yes
3	Drain Disable	Control	LOW	Applying logic <u>HIGH</u> disables drain of amplifiers	Yes
4	RF IN Over	Indicator	LOW	Pin will be latched to logic <u>HIGH</u> when input signal is over limit	No
5	Temp Over	Indicator	LOW	Pin will be latched to logic <u>HIGH</u> when amplifier is driven over temperature	Yes
6	Current Over	Indicator	LOW	Pin will be latched to logic <u>HIGH</u> when drain current limit is reached	Yes
7	ID Imbalance	Indicator	LOW	Pin will be latched to logic <u>HIGH</u> when an imbalance in the drain current of the combining branches occurs	Yes
8	PA input power	Indicator		PA input power is represented by voltage	No
9	PA output power	Indicator		PA output power is represented by voltage	No
10	PA output reflection power	Indicator		PA output reflection power is represented by voltage	No
11	VSWR	Indicator	LOW	Pin will be latched to logic <u>HIGH</u> when output reflection is over limit	No
13	+5V	Power Supply	+5V	+5V DC is supplied for reference	Yes
14	GND	Ground	GND	Ground	Yes
15	GND	Ground	GND	Ground	Yes

HIGH/LOW voltages are standard TTL signals:
 0.0V-0.8V = LOW
 2V-5V = HIGH